

TOTAL PROGRAM SPRAYING MACHINES



FLEXIBLE SPRAYING MACHINES FOR:



SPRAYING GLAZE ON POROUS CERAMICS

Spraying on earthenware, stoneware and porcelain in one or two colours. Both static spraying and robotic spraying are used here. As well as dipping a colour outside, before or after spraying the inside.



SPRAYING GLAZE ON VITREOUS CERAMICS

For bone-china. A pre-heater and a dryer are used here, either infrared or hot air type.



COLOUR STAIN SPRAYING ON READY WHITE WARE

Mostly robotic spraying, equipped with a pre-heater, dryer and a washing booth for the ware carriers (product supports).

BASIC TERMS

This is a multispray with a Coat-A-Flex robot and two auxiliary fixed spray guns. Each component is adaptable, both in amount and in its type.

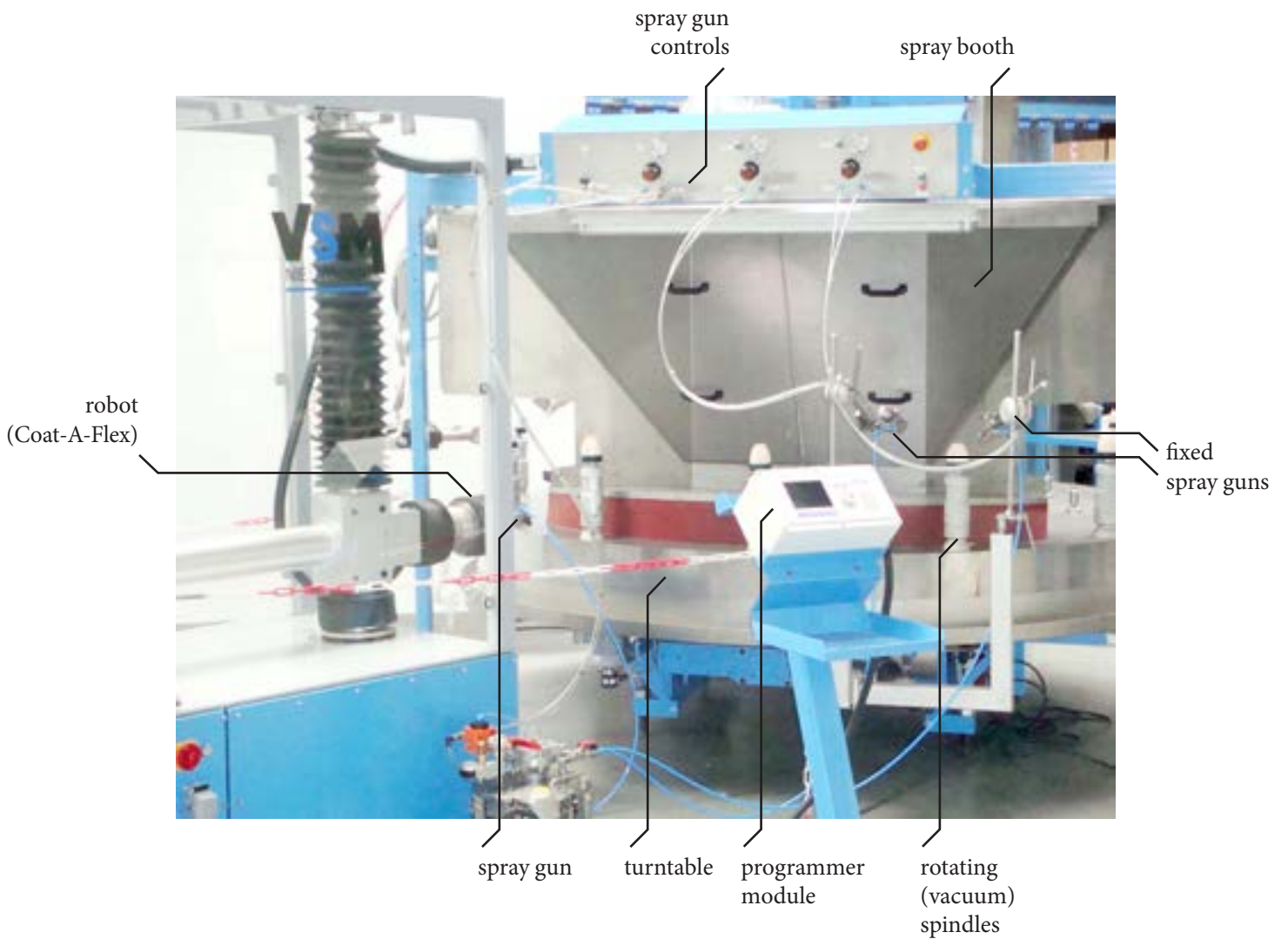

UNIQUE MACHINES

Our rotary table glaze spray machines are always unique machines, fully adapted to the production process of the customer. After all, every customer has specific requirements. In many cases our engineers are requested to design a specific solution. We can do so very economically due to our modular designs. Herein lies our strength: we can meet all your requirements for the spraying of ceramics, especially dinner- and clay-ware.

The multispray is designed for fully automated glazing of ceramic products of various shapes and sizes. The machine is fitted with product spindles on a turn-table and a number of spray booths and spray guns. Thus allowing for quick simultaneous spraying of large numbers of products, in up to four different colours. Also robots can be added to the multispray, for flexible automation.

The spraying process can be automated with robots, fast, clean, and also economical due to the collection of glaze, so you can re-use it. An optional extraction unit that circulates the filtered air back into the building can be added. Various types of product support can be mounted on the spindles easily and quickly interchangeable. Due to our modular design, our long experience over thirty years and many options, you can automate virtually any production.

THE ADVANTAGES

- Spraying large numbers of ceramic products in many shapes and sizes;
- The manually adjustable guns allow for repeatable production
- Spraying up to four different colours;
- Clean spray process with re-use of glaze;
- Modular design, with many options;
- Very high life-span with minimum maintenance;
- Turn-key delivery possible;
- User-friendly because of easy programming and cleaning, so fast change overs;
- A fully equipped test facility at VSM for optimum advising purposes;
- Specials up on request.

CONTENTS

BASIC TERMS	2
BASIC LAY-OUT	4
MULTISPRAY	6
MULTISPRAY WITH ROBOT	10
COAT-A-FLEX ROBOT	12
KUKA OR STAUBLI ROBOT	13
SPECIALS	14
MODULAR DESIGN	16
OPTIONS	18
AUXILIARY EQUIPMENT	22
TYPE DESCRIPTION	24
TECHNICAL SPECIFICATIONS	25

BASIC LAY-OUT

Our modular design consist of six table diameters, two types of spindles and various modular spray booths (wide and height)

On the right you can see some construction drawings of combinations with round turntables, spray booths, and spindles are shown in plan view. The numbers in the right corner under the drawings is the distance between the spindles. All dimensions in millimetres.

Please note, there are more options possible, like four spray booths or one big spray booth.

AMOUNT OF SPINDLES:	8	10
Model M-E D stc spindles = 2850 diameter table = 2950 spray booth = 1000 / 1400 wide PITCH		 880
Model M-D D stc spindles = 2450 diameter table = 2350 spray booth = 1000 / 1400 wide PITCH	 900	 726
Model M-C D stc spindles = 2200 diameter table = 2100 spray booth = 1000 / 1200 wide PITCH	 803	 648
AMOUNT OF SPINDLES:	3	4
Model CR D stc spindles = 1350 diameter table = 1450 Only with robot PITCH		
Model M-B D stc spindles = 1350 diameter table = 1450 spray booth = 1200 / 1350 wide PITCH	 1169	
Model M-B D stc spindles = 1250 diameter table = 1350 spray booth = 1200 wide Spraying from centre PITCH		
Model M-A D stc spindles = 810 diameter table = 910 Spray booth with opening doors PITCH		

M-D-1-7-32-PR-D

With one big spray booth.



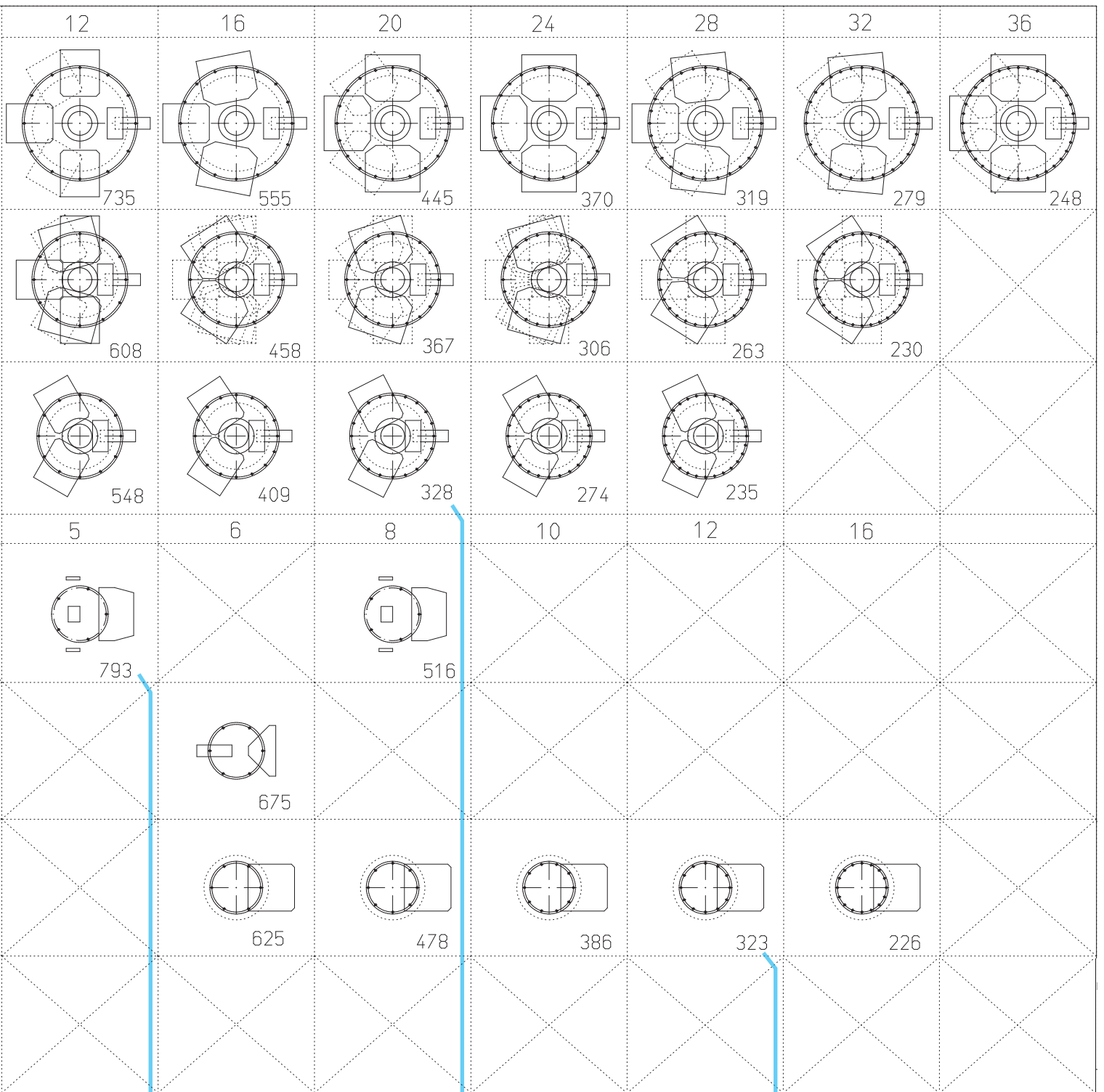

MULTISPRAY

The multispray is designed for fully automated glazing of ceramic products of various shapes and sizes. The machine is fitted with product spindles on a turn-table and a number of spray booths, thus allowing for quick simultaneous spraying of large numbers of products, in up to four different colours. The multispray is mainly made of stainless-steel and aluminium. The turn-table has a rim and collection channels for the recovery of glaze. The spray booths are fitted with a dry pre-filter and collection channels for the over-spray. When only one colour is being sprayed per booth, maximum collection and re-use of glaze is possible. This makes the spray process economical and relatively clean. An optional extraction unit that circulates the filtered air back into the building can be added. Various types of product support can be mounted on the spindles easily and quickly interchangeable. The rotation speed of the spindles can be freely programmed both C.W. and C.C.W. After a product is sprayed, the turn-table revolves gently and exactly to the required position for spraying the next product, even high thin products do not fall off. When spraying large products not all spindles are used, but every other spindle. The speed and acceleration of the turn-table is also adaptable in the programming.

ADVANTAGES

- Spraying a large numbers of ceramic products in many shapes and sizes;
- Pneumatics included;
- Spraying up to four different colours;
- Economical and clean spray process because of collection and re-use of glaze;
- User-friendly because of easy programming and cleaning;
- Modular design;
- In spite of the high wear and tear due to glaze the machine has a very high life-span;
- Easy to adjust spray guns on ball clamped arms;
- Turn-key delivery possible;
- A fully equipped test facility at VSM for optimum advising purposes;
- Many options available.



M-B-2-10

1 spray booths, 2 spray positions, 10 spindles



M-D-1-7-32-PR-D

1 spray booths, 7 spray positions, 32 spindles
With a pre-heater and a dryer.



C-3-3-20

3 spray booths, 3 spray positions, 20 spindles
With a wiper.



M-C-2-4-20

2 spray booths, 4 spray positions, 20 spindles



M-C-2-4-20-K

2 spray booths, 4 spray positions, 20 spindles
With more colour options.



M-D-3-9-24-CB

3 spray booths, 9 spray positions, 24 spindles
With an open spindle cleaning booth.

the back



M-C-2-4-20

2 spray booths, 4 spray positions, 20 spindles



**M-D-3-9-24**

3 spray booths, 9 spray positions, 24 spindles.

**M-D-2-6-32-CB**

2 spray booths, 6 spray positions, 32 spindles
With an open spindle cleaning booth.

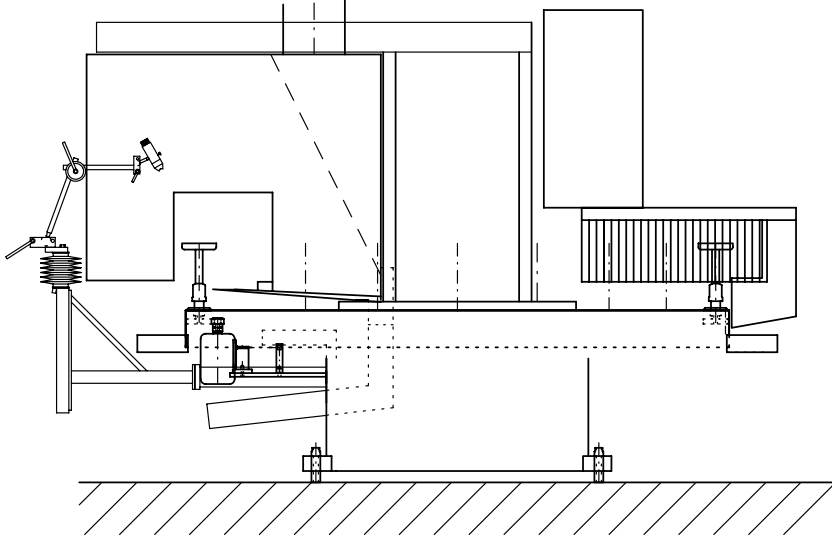
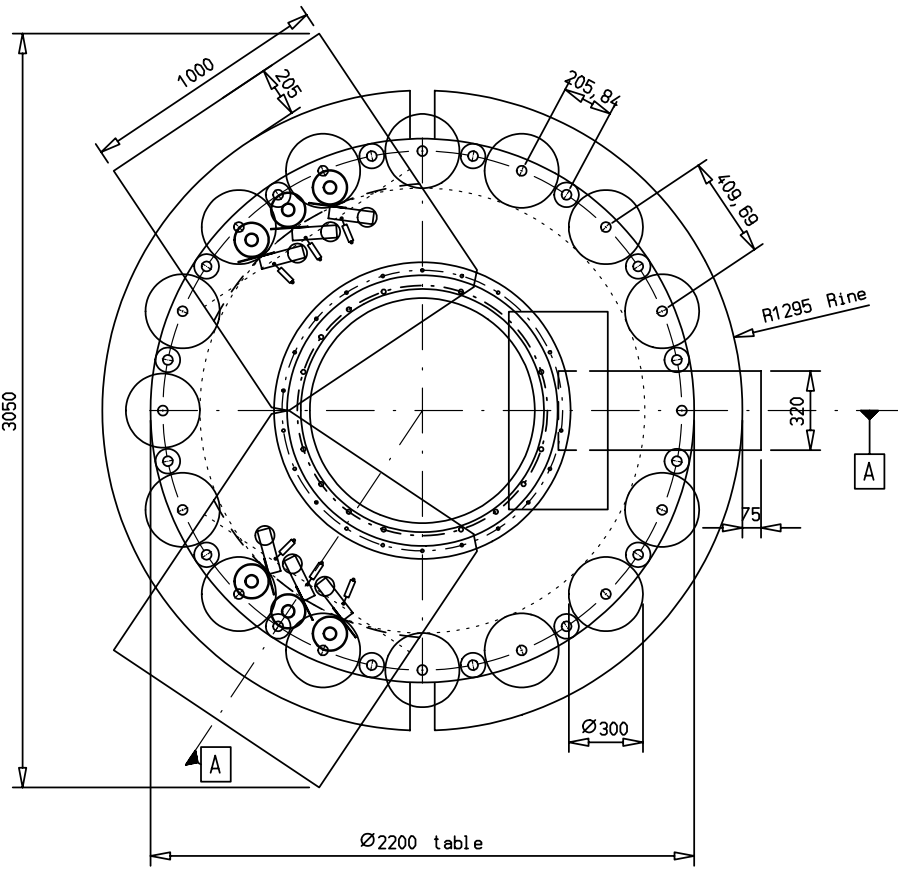

doorsnede A-A

Pos.	1	multispray M-2206-32	Material	inkoopdeel	Zaagmaat
Tek. uitvoeren		A/werking			
Engineer		Franshes MEN 3634	Tel. ISO 2768-mk	Warmebehandeling 1	
Check		08.02.2005 wrl		Warmebehandeling 2	
				File	GBAMF0AE.SZA
				Order:	verkoop
				Name:	multispray
				Scale:	1:20
				Draw. nr.:	Page: Format: A3
Modification	Date	Name	Drawing remains property of VSM Nieuwkoop BV. ALL RIGHTS RESERVED		

VSM
NEUWKOOP BV
 Transportweg 70 2424-LS Nieuwkoop NL
 Tel. ++31 (0) 172-573839
 Fax. ++31 (0) 172-574653
 email: algemeen@vsmmetal.nl

EXAMPLE

MULTISPRAY WITH ROBOT

The M-R is a combination of the multispray and one or more robots, like the KUKA or Coat-A-Flex. This results in maximum flexibility of your production process. We can build several configurations, depending on the number of robots, the number of fixed spray guns, the number of colours and the addition of pre- and post-heaters. The M-R can be fitted with a maximum of four spray booths for spraying up to four different colours. Optional are servo-driven spindles. Their positioning, rotation speed and clockwise or counter-clockwise rotation are programmed in the robot. This results in very accurate spraying of products with irregular shapes. Fixed spray guns can be added in positions around the turn-table where no Coat-A-Flex robots are required.

ADVANTAGES

- Superb spraying quality with one or more robots for fast, repeatable production;
- Available with 1, 2, 3 or 4 spray booths for spraying up to 4 different colours simultaneously;
- Very flexible and suitable to fit any production line;
- 'Just In Time' (JIT) production with high, repeatable quality products is possible;
- Easy programming of spindle drive, also for irregularly shaped products;
- Short change-over times, as all settings of the spray guns are stored into the computer;
- User-friendly because of easy programming and cleaning;
- A fully equipped test facility at VSM for optimum advising purposes.

OPTIONS

- Cup handle aligning;
- Automated load and unload logistic systems with robot or not;
- All other multispray options;
- Turn-key delivery possible.



M-C-1-1-6

1 spray booth, 1 spray position, 6 spindles



CR-B-5

1 spray booth, 1 spray position, 5 spindles



M-C-8-DR

1 spray booth, 2 spray positions, 8 spindles
With a dipping robot.



M-CAF-1-B-8-D-CB

1 robot, 8 spindles

With a closed spindle cleaning booth and dryer.



M-CAF-2-D-16-K

2 Coat-A-Flex, 16 spindles.

For two colour application, by turning over the products.



M-CAF-2-D-24-CB-PR-D

2 robots, 24 spindles.

With an open spindle cleaning booth, pre-heater and dryer.

COAT-A-FLEX ROBOT

The Coat-A-Flex is a 5-axis robot spraying system, with a programmable spindle. This guarantees an excellent result at all times, regardless of the shape or size of the products. The robot is of compact build, mounted in a powder coated steel frame, integrated with the pneumatic spraying system, material pump, controls and extras. The Coat-A-Flex is especially suitable for repeatedly spraying small series flat or hollow products. Because of the many angles that can be chosen to direct the spray gun at the product, all sides of the product can be sprayed without difficulty. This makes the spraying process extremely flexible. It sprays with great repeatability

ADVANTAGES

- Products can be sprayed from all angles;
- Very flexible and therefore suitable for many applications;
- Spraying process is fast and economical because of accurate positioning of the spray gun;
- Short change-over times;
- Extremely user-friendly because of easy programming and cleaning;
- It contains a point to point teach programming method.

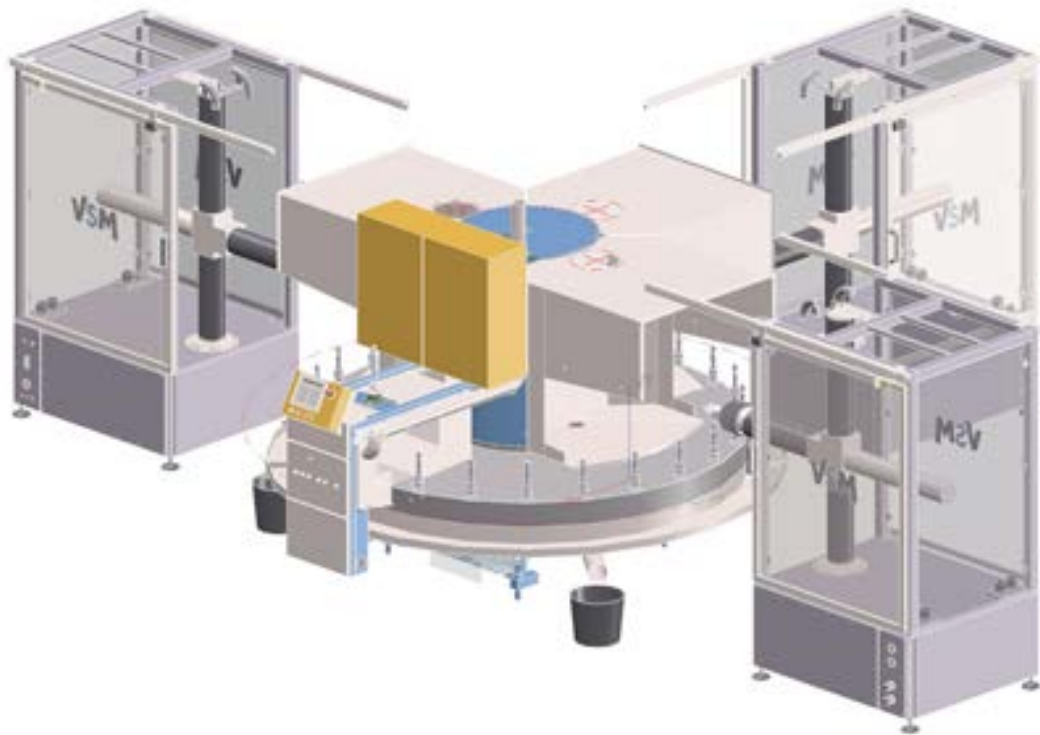

KUKA OR STAUBLI ROBOT

KUKA or Staubli with a Krautzberger RA-5 spray gun

- KUKA or Staubli robot
- 7th product axis, for positioning purposes;
- 2 Spraying air proportional valves (round and flat air);
- Adapter for Krautzberger RA-5 Spray gun;
- Robot bus-connection to the VSM unit;
- Basic spraying program (by VSM) included.



CR-08



CR-08

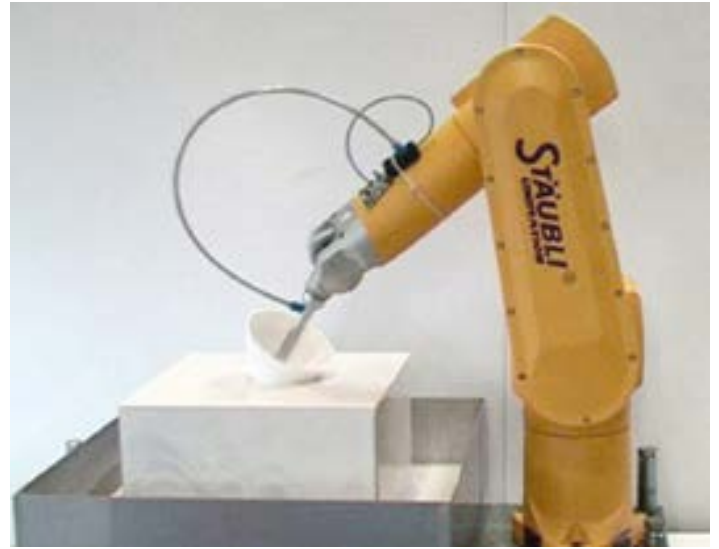

ROBOT DIP

Another way of glazing.

This machine is intended to do two coloured porous hollowware. Outside by dipping just to the upper edge, by means of a robot which levels the upper rim of the product with a sensor. Then it foot wipes and places it on the round table spraying machine where it will be inside sprayed by means of an air knife preventing spray mist getting over the edge, contaminating the outside.



SPECIAL

With dipping, spraying, load and unload.

SPECIALS



TURNING UPSIDE DOWN ONTO A SECOND MACHINE



SPRAYING WITH A MASK

Contour of un-roundness is compensated by servo motion. After a previous measurement with laser sensor. Before spraying it is precisely brushed.



IN LINE BRICK SPRAYING MACHINE

A 4 lane wide spraying system to spray 3 sides of a brick. With easy access to the spraying guns. Photo shows open situation, in production the booth is closed.

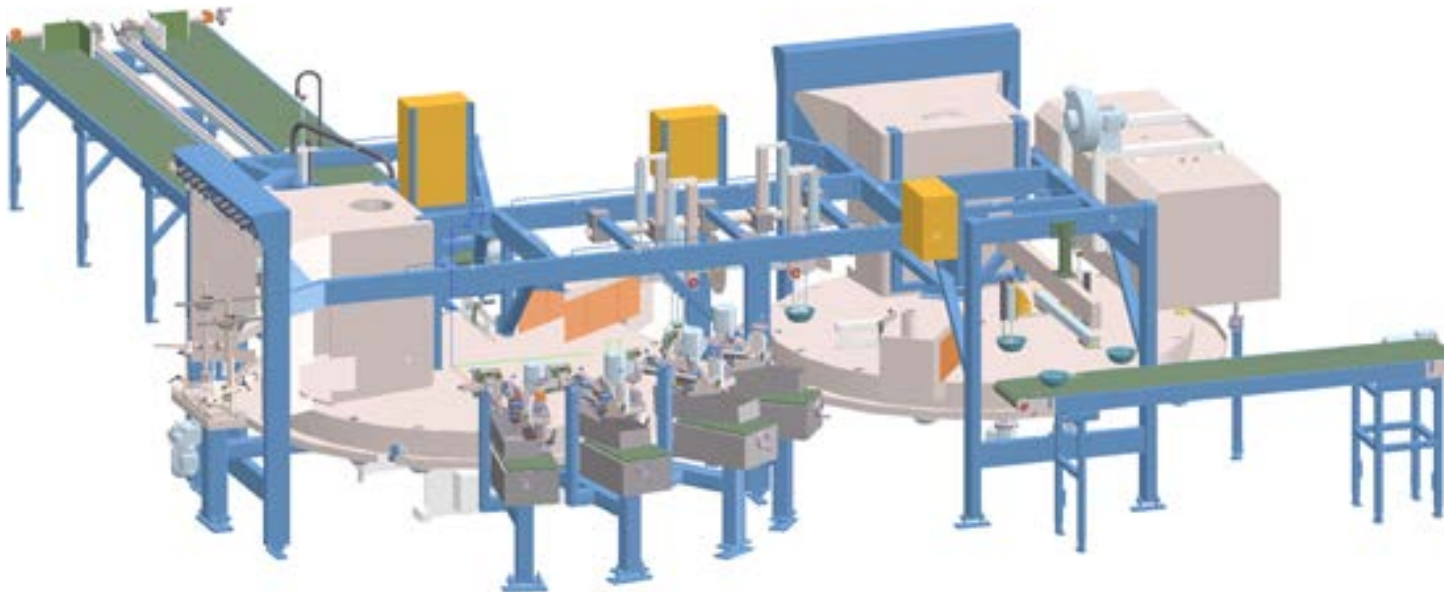

MACHINE TO SPRAY DINNER PLATES INTO 3 COLOURS

A double lane lay-out with automatic load, spraying, foot wiping, turning over, centralising, and unload.

PRODUCT LOADING AND UNLOADING

We have developed multiple solutions here to solve automation on spraying machines. The following is just one or two examples. Products can be loaded on the spindles by pneumatic cylinders. We use then our own flat vacuum pads. For the feeding of products a 2 conveyor system is used, facilitating the centring of the ware in a plastic V-shaped block. To turn the product over to an adjacent 2nd machine we have developed a very nice transfer unit. A product has been picked up turned and now being transferred to a 2nd vacuum pad which takes it up at the not sprayed back, turns, and places it on the others' machine's spindle. For centring transfer we have constructed devices to measure the products off centre placement on a spindle turn it then to the most far position, and the accordingly adjusted vacuum pad picks it then dead centre up to place it on a adjacent machine.



MODULAR DESIGN

FRAME

The basic frame is very rigid, one modular frame design is used for most applications. A second frame is mounted onto the base frame, onto which the spray booths and the control cabinet are fitted. Both frames are powder coated to ensure protection against moisture ingress. The machine can be transported as a complete unit.

TURNTABLE

The Aluminium or stainless-steel turntable is mounted on a hollow geared bearing ($\varnothing 1200$ mm, slewing ring) onto the base frame. The turntable gives optimal protection to the motors beneath the frame. On top of the smooth turntable, the spindles are fitted watertight. The perimeter is surrounded by a lowered edge, under which glaze-collecting channels are installed to facilitate recovery of glaze. This also keeps the floor clean. The turntable, together with spindles, is rotated 1 or 2 spindles further after each spraying sequence. Very precise and smooth propulsion of the turntable is attained by using a closed loop frequency inverter regulated drive which, in combination with the PLC, provides a sinusoidal acceleration / deceleration curve (even high vases remain steady). The speed is infinitely adjustable. For precise robotic use we can also provide a backlash free drive, which gives a very accurate quick drive.

SPINDLES

The anodized Aluminium/stainless steel spindles are engineered using a well-tested method that gives a long life span. The outside of the spindles is smooth and rounded so that no glaze is left behind in any corners. The double special closing seal is constructed so that glaze drops off (upside down) to prevent glaze entering the bearings. The spindles are fitted with product support cones allowing fast changing of the product carriers. The spindles are standard supplied with aluminium extensions.

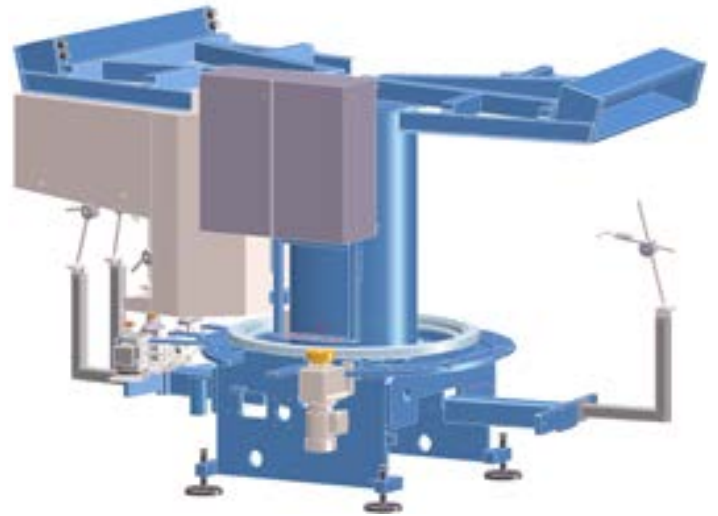

For a technical drawing of a spindle, see page 27.

SPINDLE DRIVES

Each spindle is driven by its own F.C. regulated motor. The meshing of motor and spindle is with a maintenance free linear movement. A nice and controllable acceleration is applied. In case of robot use, it has gears with a pneumatic cylinder. For those we can also implement a robot axis to control the spindle to index the product.



SPRAY BOOTHS

The stainless steel spray booths have a high efficiency, easy to wash pre-filter. The spray booth needs to be connected to a separate extractor unit. Because of the smart design of the spray booth (a smooth inside with rounded corners) they can be cleaned very easily. A tube on the underside runs through the middle of the table to the front and provides recovery of the over-spray. There are also halogen lights on top of the spray booths. To facilitate easy cleaning we can optionally coat the inside of the booth with a non-stick coating. The booths are from 800 up to 1200 mm wide, or up on request to 2500 mm.



ELECTRICAL EQUIPMENT

The central control box with PLC is located over the machine between the spray cabinets (not at M-CAF-3). For safety, automatic electrical cut-outs are incorporated in this central control box. Modern frequency regulators control all motors. The complete system is PLC controlled, assuring optimal control. Input is via a 8" colour touch screen or a 2 line display (optionally). The system can be connected to internet for easy service in case of errors.

SAFETY

Two doors with switches between each Coat-A-Flex and the turntable machine guarantee safety between the moving robot spray gun and the spray booth. For safety on the turntable with the spindles, the booths are equipped with 40 mm thick rubber switches. So if an arm or hand comes between a spindle on the moving turntable and a booth, the switch is made. Now the table stops immediately and turns back to release the arm from the rubber and no harm has been done. Furthermore the machine has an emergency switch and is built conforming the various norms referring to the Machine Directive and is CE approved.



OPTIONS

If technically possible, we can make any special wish in round table spray machines due to our modular design and great experience.

VACUUM SPINDLES

The anodized aluminium spindles are engineered according the same method. The outside of the spindles is smooth and rounded so that no glaze is left behind in any corners. The spindles have coarse thread and a centring edge allowing changing of the product carriers. The spindles are standard supplied with aluminium extensions. For the vacuum we have invented a very cunning system. Each spindle has a Piab multistage pneumatic vacuum ejector, working on max 2,5 bars compressed air. To clean or exchange this you just pull the unit out, and clean under a water tap or insert a spare one. Inside the spindle is a space which may fill up with glaze but the vacuum pipe sticks out higher so it will remain clean. For even better cleanliness there is a sintered polyethylene filter. To place products on the spindles, a foot switch is used to take the vacuum locally off. At the cleaning booth there is a cover over the spindle. Pressure is supplied to the spindles though a special hollow rotary joint (leaving space in the middle to provide for frame work and glaze collecting tubes) and a reducing valve.

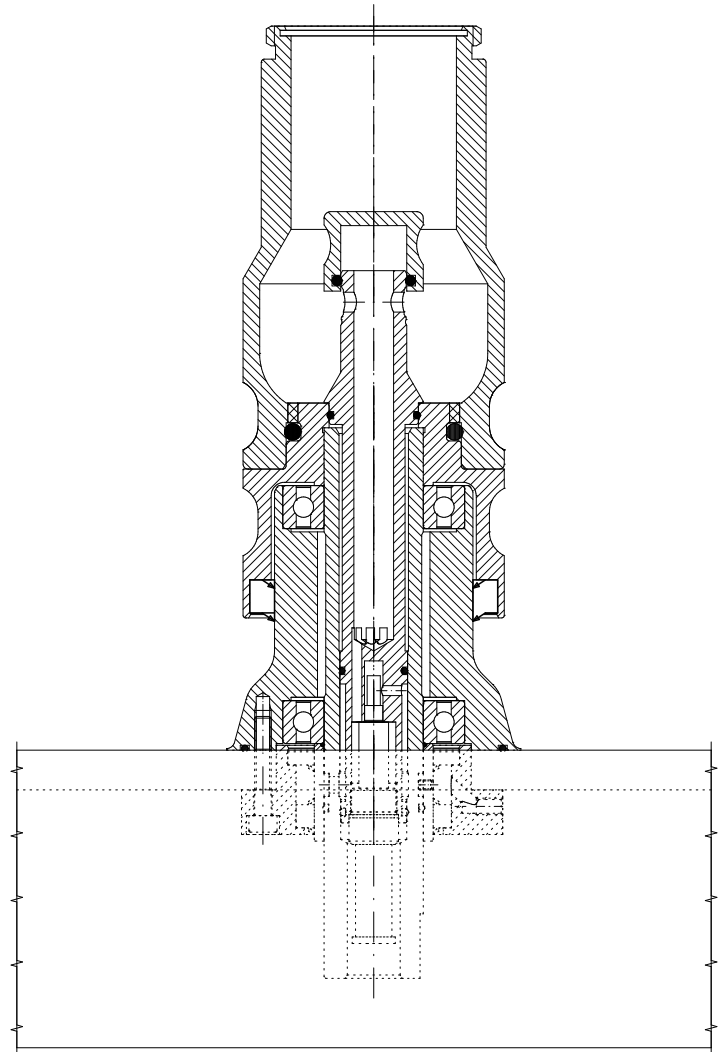

RAPID ADJUSTMENT ARMS FOR AUTOMATIC SPRAY GUNS [M-GUN-A-800]

The automatic spray guns can be mounted on rapid adjustment arms. These arms are made almost entirely of stainless steel, and give the facility to rapidly position the spray gun into the correct direction, without the use of any tools. As a result of a design making use of ball joints, these arms have a long life span. One spray gun can be mounted per arm.



PRODUCT SUPPORTS

There are several types of product supports possible. They're all rapidly interchangeable on the spindle cones.

1. Plastic disk: if the underside of the product does not require spraying, then double-sided plastic product supports can be used on top of which the product can be fitted concentrically.

2. Narrow ring: if the underside of the product does need to be sprayed, we can deliver narrow product support rings that stand on four pins.

3. Adjustable 4 point: adjustable 4-point supports in a variety of diameter ranges.

4. Wire: we have product carriers where the product rests on four stainless steel wires, avoiding shades.

5. Blade: the products can be put on the three sided saw blade type carriers.

6. Silicone: for precise positioning we also supply pre-machined plastic disks to cast a rubber or silicone edge on it, for use with vacuum spindles.

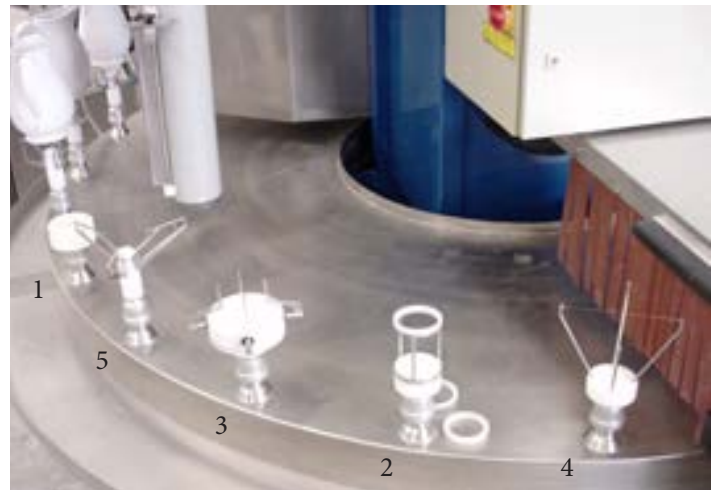
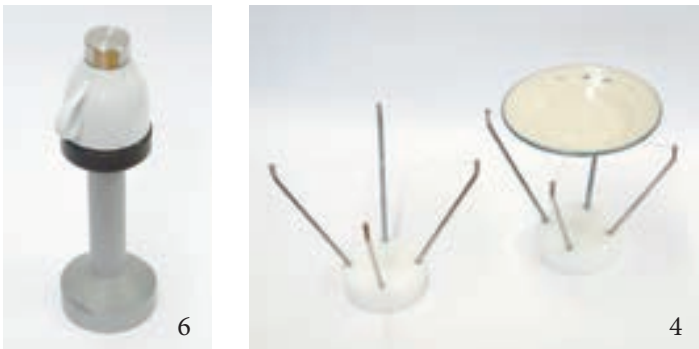
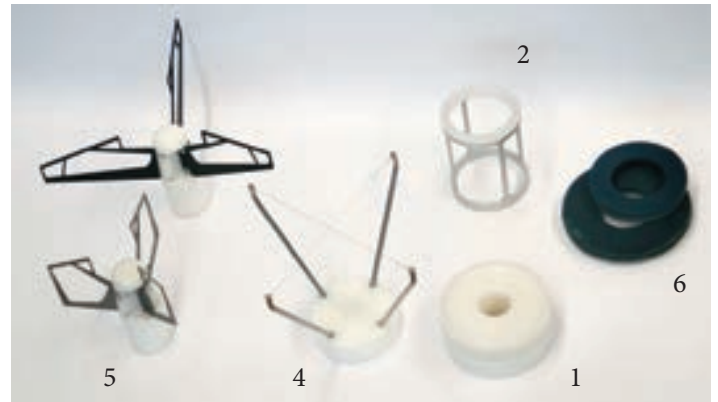

RINSE BOOTH (OPEN)

This is a wash booth to clean the product carrier after a sprayed product is taken off, facilitating a clean carrier for the new product. The booths are with two sliding doors. Inside the spindle rotates while being cleaned with 2 air/water jets. After washing, 3 jets of air blow off the last drops of water. Outside this booth a hot air dryer is applied, to be sure it is dry. When vacuum spindles are applied, a cover is used preventing water flowing into the vacuum unit.



RINSE BOOTH (CLOSED)

This open booth is used when a drop of water is allowed for. So without hot air dryer.

PREHEAT AND DRYERS (INFRA RED)

The heater units are of the movable type both in vertical and diametrical position. The heater modules themselves are IR quartz glass carbon wire heaters. They give a very good heating efficiency on ceramic ware due to the wavelength. With the pulse wide modulation controle, one can set also smaller arias to save more energy. With these units a very clean (virtually no air movement around the product) heat is applied to the product. Either to heat it up or to dry products.

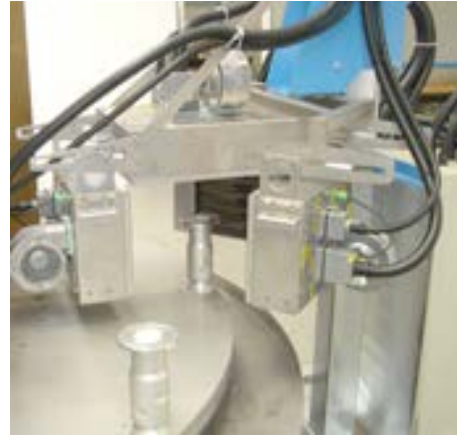

PREHEAT AND DRYERS (HOT AIR)

An other possibility is the very precise regulated Leister hot air heating units (max 600° output) with a pre-filtered airflow. These are more economic in use and costs. But are more sensitive to the hot air direction to the product. Therefore we have put them on our proven rapid adjustment arms.



VERTICAL LIFTERS AND HORIZONTAL MOVERS FOR SPRAY GUNS

The lifters consist of air cylinders in which the piston can not rotate. Surrounding the piston rod is a special saerated rubber bellow that provides 99,9% protection against the glaze. They are used to spray tall cylindrical products. The horizontal movers are situated under the rotary table and are driven by an pneumatic cylinder, for stability reasons they are connected to a linear guide bearing (stroke is 250 mm). These are mostly used to spray flat surfaces as plates etc. On both units we put a Rapid adjustment arm to put on a spraying gun. The movers provide a steady movement using an air buffer tank. The speed can be adjusted using a rotary knob next to the cylinder. In the controls is a time for the spraying, and a post- time is incorporated to compensate for the delay of the spray gun. A special insert lifter can be used to spray the inside of narrow, tall products. A extended automatic spray pistol with adjustment arm is delivered with these lifters.



Horizontal



Vertical

INSIDE SPRAY GUN

Spray gun for narrow products apart inside spraying

We can deliver extensions on spray guns, they are mounted on a servo pneumatic cylinder, for adjustable controlled speeds. The spray head can be used to enter products from an opening of \varnothing 40 mm. The height is variable.



PRODUCT POSITIONING LASER LIGHT

To enlighten the positioning of the products in the centre of the product carriers, which have no self-centring ring, a laser light beam can be used. In this way the operator can centre the products on the carriers with more ease. Also used for align cup handles.



COATED SPRAY BOOTH

For easy cleaning, the booths can be supplied with a non-sticking coating.



BACKLASH FREE TABLE DRIVE

The CR-types have a zero backlash robotic gear box. The other multispray machines can optionally have a pre-tensioned sprocket drive. I.e. two gears spring-load on top of each other.

AUXILIARY EQUIPMENT

SPRAY GUNS AND GLAZE PUMP SYSTEMS

We provide any make and type of Robot spray guns and pump systems

The glaze pumps GP-370 and GP-750 are a centrifugal pumps with an extension mounted on an electric motor, and is available in two sizes. This pump stands on three legs in the container. The pump feeds the circulating spray guns with glaze. A junction piece is provided for additional spray guns, each with its own shut-off valves. Using a mixing paddle, the supply is kept in motion. GP-M-3/4 is a membrane type pneumatic action pump. For ease of handling the pumps can be mounted to balance filters.

	GP 370	GP-750	GP-M-3/4
Motor power and rpm	0.37 kW, 1400 min ⁻¹	0.75 kW, 1400 min ⁻¹	-
Number of outlets and diameter	3 - 12 mm	6 - 12 mm	
Maximum pressure	1.5 – 2 bar	1.5 – 2 bar	4 bar
Internal length	500 mm	630 mm	-
Height	850 mm	1060 mm	-
Weight	16 kg	29 kg	10 kg
Pneumatic			1-4 bars

WIPE 3

The cleaning belt is composed of high technology materials, and is used to remove the excess glaze from the underside of the product, ensuring a clean finish. The belt runs through a water underneath and, as the belt returns to the top side, it is squeezed between two rollers to remove excess water.

Advantages

- The machine needs only a very small area due to the drive motor is situated under the machine;
- The water container can be easily removed like a drawer and cleaned;
- The machine height is easy adjustable;
- The machine can easily be moved;
- The sponge belt is made from “open cell sponge rubber”, with a mid-tape string to ensure the tape remains in position;
- It only takes 10 minutes to replace the belt;
- Many sorts of belts are available of varying hardness.



Sponge surface (width x length)	360 x 400 mm
Motor reductor power	0.18 kW
Belt speed	7.5 m/min
Weight	100 kg
Bearings individually sealed	
Finish	Dual component paint
Stainless steel	DIN 1.4301
Surface needed	580 x 520 mm
Adjustable Height	850 – 1000 mm

MIXING SYSTEMS

Various glaze mixing systems are available

The mixer consists of a solid under frame, upon which a large tube is fitted. There are 4 braked swivel casters fitted under this frame. A stable carriage, running on ball bearings, is screwed onto the vertical tube, for the height adjustment. The motor of the glaze pump and the control box (conforms to IP 55) are fitted onto the linear carriage. The carriage can be locked on each level. The tube contains a counter weight for the motor carriage, so that adjustment of this carriage takes little effort. The length of the three-bladed stainless steel mixer screw is adjusted to suit the depth of the container, to ensure that the mixer screw does not touch the bottom. A switch controls the motors. A cam switch (adjustable in height) which switches off the motor if the motor is lifted provides safety for personal.

PUMP HOLDER

The mixer also carries out the function of glaze pump holder, with the objective to make the heavy glaze pumps as light as possible. In this construction the mixing motor is omitted and a glaze pump can be fitted. On both units it is possible to put a frequency inverter

Mixer Power and RPM	0,75 kW, 1450 min ⁻¹
Required floor space (width x depth)	1000 x 900 mm
Total height mixer	2650 mm
Maximum height adjustment	1000 mm
Diameter barrel	Max. 760 mm
Finish	Dual component paint
Weight	Ca. 200 kg



EXTRACTION SYSTEMS

Various extraction systems can be used see separate proposals.

The multispray can be linked with an extraction installation, that, depending on the design can even return the removed air to the working area. The types that can be delivered by VSM are the Keller Vario Star, Keller Cyclo Separator, Kiekens Dustmaster and Delta Neu.

The extractor make Keller Vario Star is a very reliable unit, and incorporates a quality air pressure filter cleaning system. Using this unit, the filtered air can be returned within the building. With a proven outlet of only 0,1 milligr dust per m³. Also from Keller is a cyclo filtering unit with a separate fan motor for separating parts as small as 15 µm.

Another available extractor installation is manufactured by Kiekens. This unit incorporates a vibrating motor cleansed filter system using fabric filtration material. All the extractors are attached to the spray machine booths with tubes. Holes and feed-throughs to the building roof are to be made by the customers.

TYPE DESCRIPTION

Machine configurations: Multispray

M - A/B/C/D/E - 1/2/3/4 - 1/2/4/6/8 - 3/36 - X

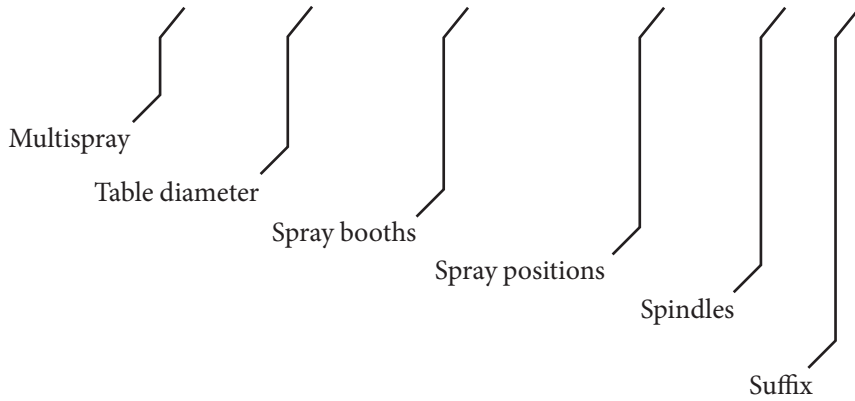

Machine configurations: Multispray with robots

M - CAF/R - 1/2/3 - A/C/D/E - 3/36 - X

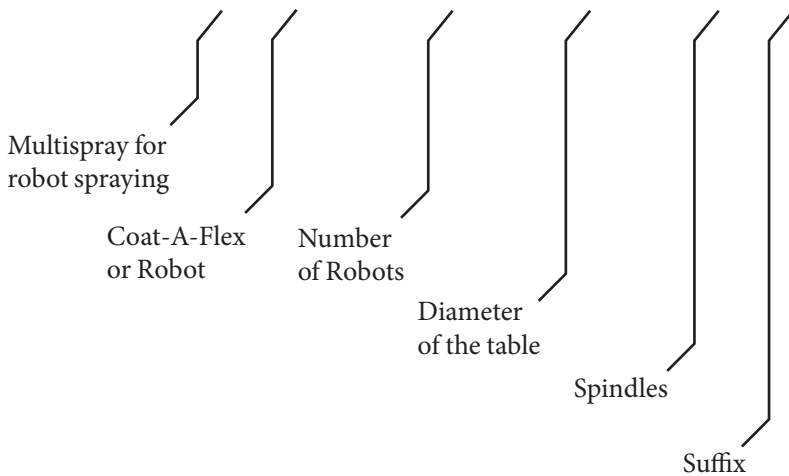

Machine configurations: Compact type

C R - B - 5/8 - X

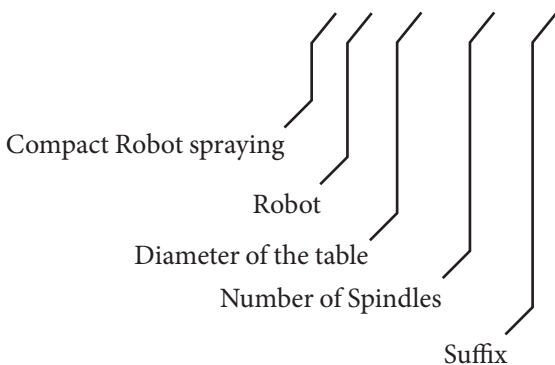

SUFFIX DESCRIPTION

- CB A spindle cleaning booth is placed
- D A dryer is placed
- DR Dipping Robot is placed for dipping / spray actions
- K The 2 booths placed on an other position (to spray two colours on one machine).
- LT A ware load transfer is placed
- PR A pre heat is placed
- T A ware transfer is placed
- V Vacuum spindles are applied
- X Special

TECHNICAL SPECIFICATIONS

DESCRIPTION	M-E	M-D	M-C	CR-B	M-A
Table diameter					
Product: hollow ware (Ø x H)	Ø 400 x 500	Ø 400 x 500	Ø 400 x 500	Ø 300 x 200	Ø 450 x 400
Product: flat ware (Ø)	Ø 500	Ø 500	Ø 500	Ø 350	Ø 450
Product weight maximum (kg)	20 (on standard spindle)				
Turntable height	Adjustable from 700 - to 800 + spindle approx 200				
Turntable outside diameter	Ø 2950	Ø2450	Ø 2200	Ø 1450	Ø910
Spindle pitch diameter	Ø 2850	Ø 2350	Ø 2100	Ø 1350	Ø 788
Number of spindles	8-36	8-24	8-20	5-8	3
Distance spindle to spindle 3	-	-	-	-	682
Distance spindle to spindle 5	-	-	-	795	-
Distance spindle to spindle 6	-	-	-	-	-
Distance spindle to spindle 8	-	899 *	803 *	516	-
Distance spindle to spindle 10	880 *	726 *	648 *	-	-
Distance spindle to spindle 12	737	608 *	540	-	-
Distance spindle to spindle 16	550	455	405	-	-
Distance spindle to spindle 20	442	365	328	-	-
Distance spindle to spindle 24	370	305	272	-	-
Distance spindle to spindle 28	318	261	-	-	-
Distance spindle to spindle 32	278	228	-	-	-
Distance spindle to spindle 36	247	-	-	-	-
Table speed spindle to spindle (depending on distance)	1-5	0.8 - 5	0.8 - 5	1 - 4	3 - 5
Spindle position accuracy	± 0.7 (at precision option ± 0.35)				
Number of spindle revolutions	10-200				
Number of robots possible	1-4	1-3	1-2	1	1
Other spray positions (fixed guns)	option	option	option	-	-
Spraying air	from robot				
Number of spray booths, dims. mm	1 - 4 - 800 - 200 mm, option 2500				
Stainless steel, type	ANSI: 1.4301				
Machine colour	powder coating blue RAL 5017				
Electrical connection rates	400 V AC, 3ph, 50 Hz power : 1-3 kW				
Protection (depending on location)	IP 54/55/56				
Dims (L x W x H) without extraction and robots	3900x3400x1900	3400x3100x1900	3100x2550x1900	3300x3500x2350	1180x1400x2100
Weight without robots (kg)	1900	1700	1600	2000	700
Pneumatic spray gun actuators					
Speed	0.7 - 30 m/min				
Vertical movement	400 mm				
Number of lifters max.	8				
Insert sprayer lifter vertical movement	300 or 400mm				
Product opening minimum	Ø 45 mm				
Air consumption lifter per movement	1.6 NL				
Units distances: mm, rotation min-1, power: kW, time: sec, NA: not available					

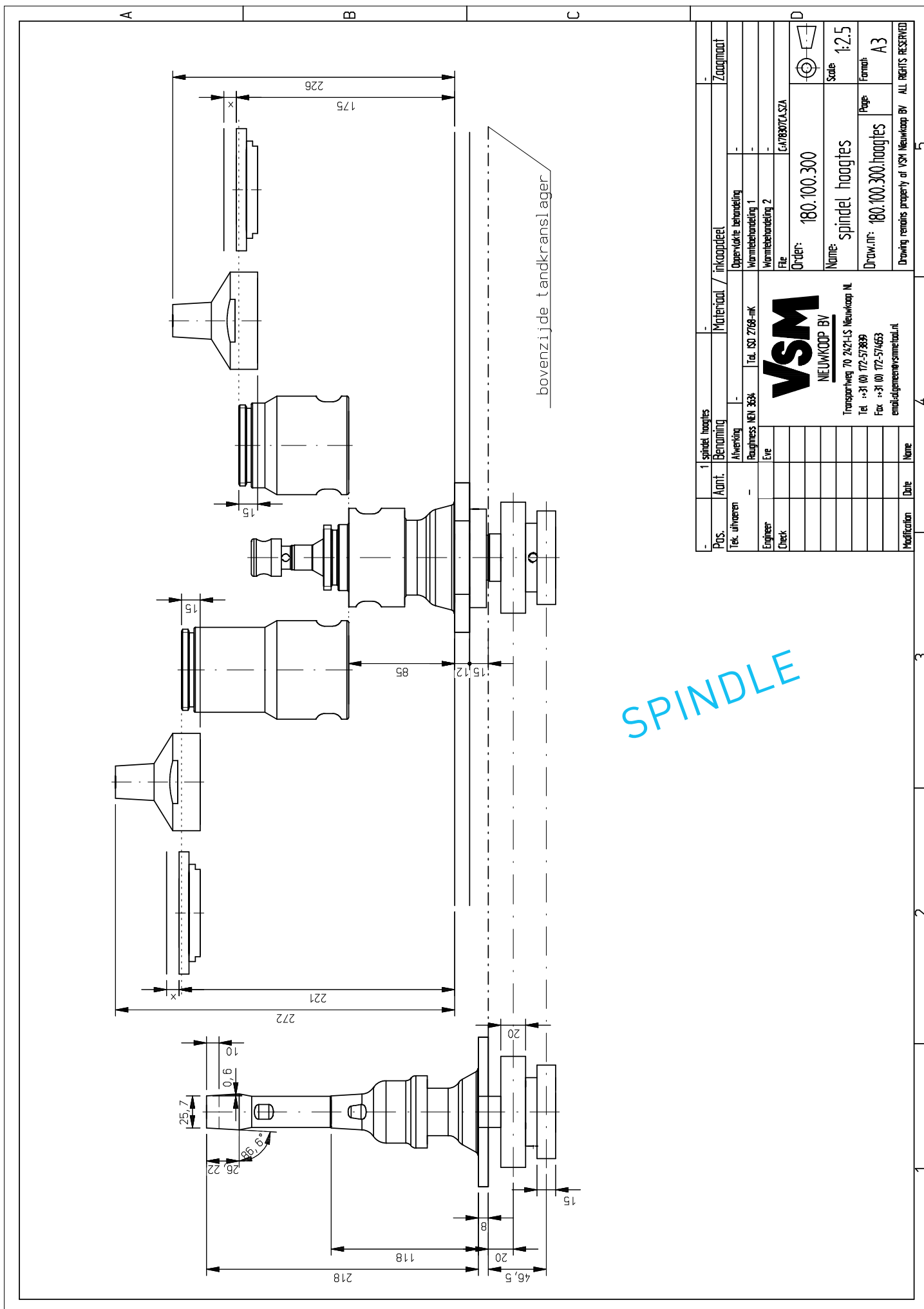

SPINDLE

1 spindel hoogtes		Materiaal /		inkoopdeel		Zaagmaat	
Pos.	Aant.	Benoaming					
Tek. uitvoeren		Afwerking	Oppervlakte behandeling				
Engineer		Roughness NEN 364	Tal. ISO 2768-mK	Warmtebehandeling 1			
Check		Eve		Warmtebehandeling 2			
				File		G478307A.SZA	
				Order:		180.100.300	
				Name:		spindel hoogtes	
				Scale:		1:2.5	
				Draw. nr.:		180.100.300.hoogtes	
				Page:		A3	
Modification		Date	Name	Drawing remains property of VSM Nieuwkoop BV ALL RIGHTS RESERVED			



VSM is renowned for its outstanding after-sales practice. Turn key delivery of the machine, training of your operators, maintenance and problem solving can be included. Therefore you can be sure of a quick start and a smooth operation of the machine in your production line.

VSM Nieuwkoop	Tel. +31 172 - 573839
Transportweg 70	Fax +31 172 - 574653
2421 LS Nieuwkoop	www.vsmmetaal.nl
The Netherlands	info@vsmmetaal.nl
